



# Pérgola 90x96



## Características y aplicaciones



Completando el sistema Sferic tenemos la variante 90x96 mm., aún más robusta, de perfilera cuadrada.

Esta variante del diseño del sistema aporta un toque extra de solidez visual, manteniendo todas las opciones que nos brinda la esfera.

Con el sistema Sferic se reduce considerablemente el número de piezas en stock necesarias para acometer cualquier proyecto de toldo plano.

La gran versatilidad del sistema supera las limitaciones que plantean otros sistemas.

Medidas máximas por módulo: 7 metros de línea por 7 metros de salida con 3 guías

**100% ROBUSTEZ**

## Characteristics and applications



Completing the Sferic system have the option 90x96 mm., even more robust, square profiles.

This variant of the system design provides an extra touch of visual strength, keeping all that gives us the sphere.

With the spherical system Sferic significantly reduces the number of parts in stock necessary to undertake any project awning plane.

The great versatility of the system overcomes the limitations posed by other systems.

Maximum measurements per module: line 7 meters by 7 meters projection with 3 guides.

**100% STRENGTH**

## Caractéristiques et les usages



Remplir le système Sferic de l'option sphérique 90x96 mm, encore plus robuste, square profiles.

Cette variante de la conception du système apporte une touche supplémentaire de force visuelle, en gardant tout ce qui nous donne le sphère.

Avec le système Sferic réduit considérablement le nombre de pièces en stock nécessaire de procéder à n'importe quel projet de store plane.

La grande polyvalence du système permet de surmonter les limites posées par d'autres systèmes.

Mesures maximales par module: ligne 7 mètres par 7 mètres projection avec 3 glissières.

**FORCE 100%**

## Eigenschaften und Anwendungen



Zur Vervollständigung des Systems Sferic haben wir die noch robustere, quadratische 90x96mm Variante gebaut.

Diese Variante des Designs des Systems bringt einen zusätzlichen Hauch von Gediegenheit und hat alle Optionen, die uns die Sphäre bietet.

Mit dem Sferic wird auch das Lagersortiment an Komponenten wesentlich reduziert.

Die Vielseitigkeit des Systems überschreitet die Grenzen, denen andere Systeme gesetzt sind.

Maximale Messungen pro Modul: Linie 7 x 7 Meter Projektion mit 3 Führungs.

**100% ROBUSTHEIT**

## PERFILES Y ACCESORIOS PARA ESTRUCTURAS 90x45



Soporte Articulado Sferic 90x96

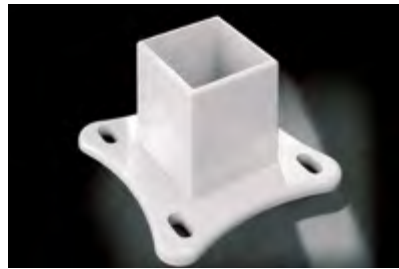

Pie Sferic 90x96



Soporte Guía 90x96



Rótula Sferic 90x96



Guía Sferic 90x96

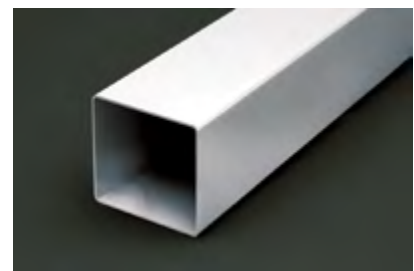

Perfil Sferic 90x96



Tapón Adaptador Sferic 90x96

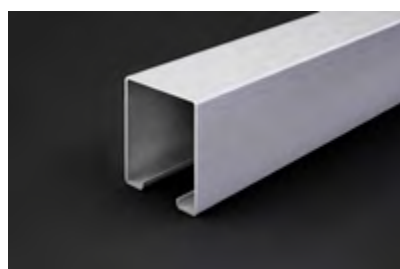

Empalme Guía y perfil 90x96



Protección Solar y Cerramientos



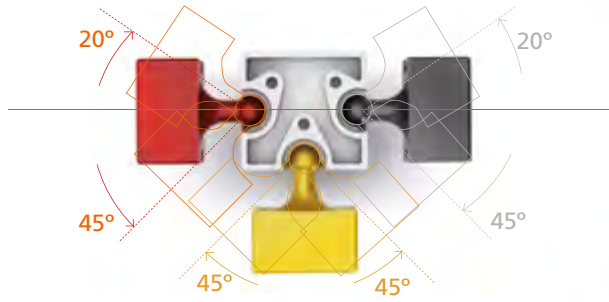

**ÁNGULOS POSIBLES SISTEMA SFERIC 90x96**

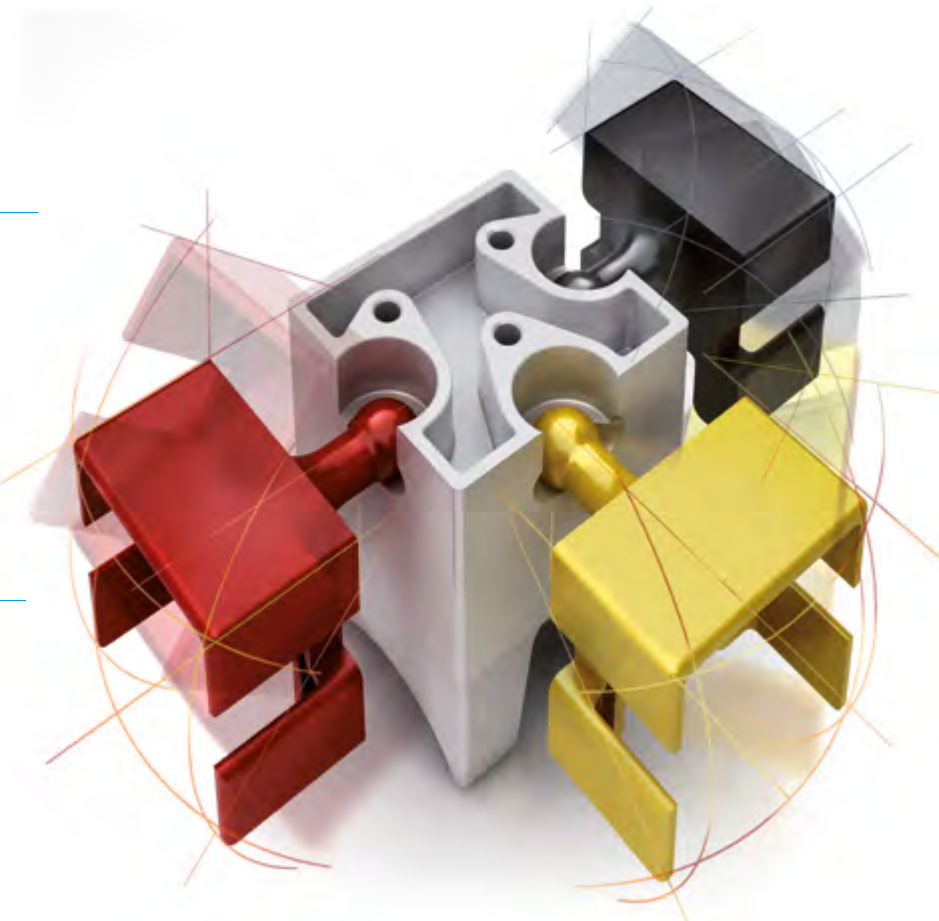
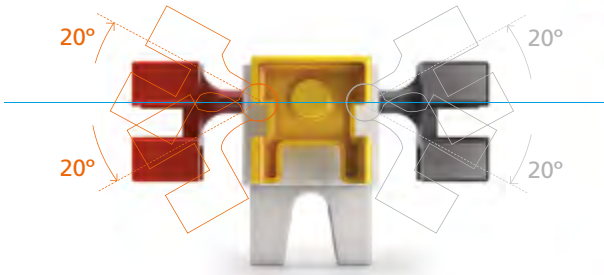

También se han diseñado nuevos terminales y capiteles para poder montar pérgolas decorativas con esta nueva perfilería.



Also new terminals and capitals are designed for mounting decorative pergola with these new profiles.



Aussi de nouveaux terminaux et capitales sont conçus pour le montage de pérgolas décoratifs avec cette nouvelle profils.



Außerdem wurden neue Terminals und Kapitelle für die Montage von dekorativen Pergolen mit diesen neuen Profilen entworfen.



Soporte Capitel Pecho Paloma 90x96



Terminal Pecho Paloma 90x96



Soporte Pérgola 90x96



LA REVOLUCIÓN ha llegado al sistema de toldo plano, SIPLAN lo ha hecho posible.

The Revolution has reached the flat awning system, SIPLAN has made it possible.

La Révolution a atteint le système store plane, SIPLAN a rendu cela possible.

DIE REVOLUTION ist bei dem Flachmarkisensystem angekommen. SIPLAN hat es ermöglicht.

Sferic®  
by SIPLAN

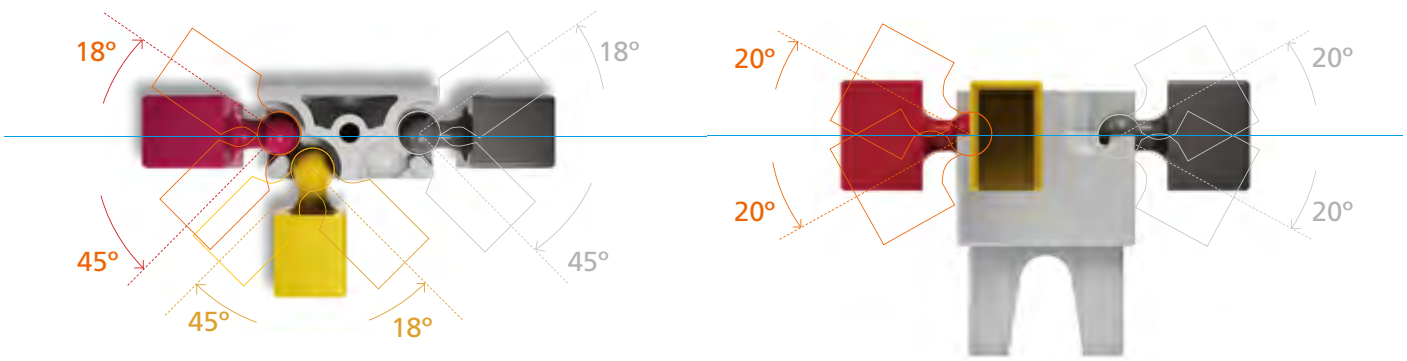

**ÁNGULOS POSIBLES SISTEMA SFERIC 90x45**

D I N Á M I C O  
R E V O L U C I O N A R I O  
DYNAMIC / REVOLUTIONARY  
DYNAMIQUE / RÉVOLUTIONNAIRE  
DYNAMISCH / REVOLUTIONÄR



Protección Solar y Cerramientos

Tlf. 657-396-108

[www.toldosmontequinto.com](http://www.toldosmontequinto.com)